



SP100/120

Max Flow: 100 gpm (379 lpm)

SP100/120 Spin-On Filters

Working Pressures to: 150 psi
1035 kPa
10.3 bar

Rated Static Burst to: 250 psi
1725 kPa
17.2 bar

Flow Range to: 100 gpm
379 lpm

Features

SP100/120 double filter head allows for double the flow capacity and a unique, space-saving configuration. Aluminum casting and Buna-N® seals standard. SP100/120 filters are interchangeable with SP50/60 filters.

Buna-N® is a registered trademark of E. I. DuPont de Nemours and Company.



Beta Rating

- Performance to $\beta_{<4(c)} = 1000$

Porting Size Options

- 1½" NPT

Replacement Filter Lengths

- 6.7" / 170 mm
- 7.0" / 178 mm
- 10.7" / 271 mm

Standard Bypass Ratings

- 25 psi / 172.5 kPa / 1.72 bar

Assembly Weight

- 7.0 lbs / 3.2 kg (short)
- 8.8 lbs / 4.0 kg (long)

Operating Temperatures

- -22°F to 225°F / -30°C to 107°C

Filter Collapse Ratings

- 100 psid / 690 kPa / 6.9 bar



SP100/120 Specification Illustrations

All dimensions are shown in inches [millimeters].

Assembly - Side View

Applications

- Fluid Conditioning Systems
- In-Plant Systems

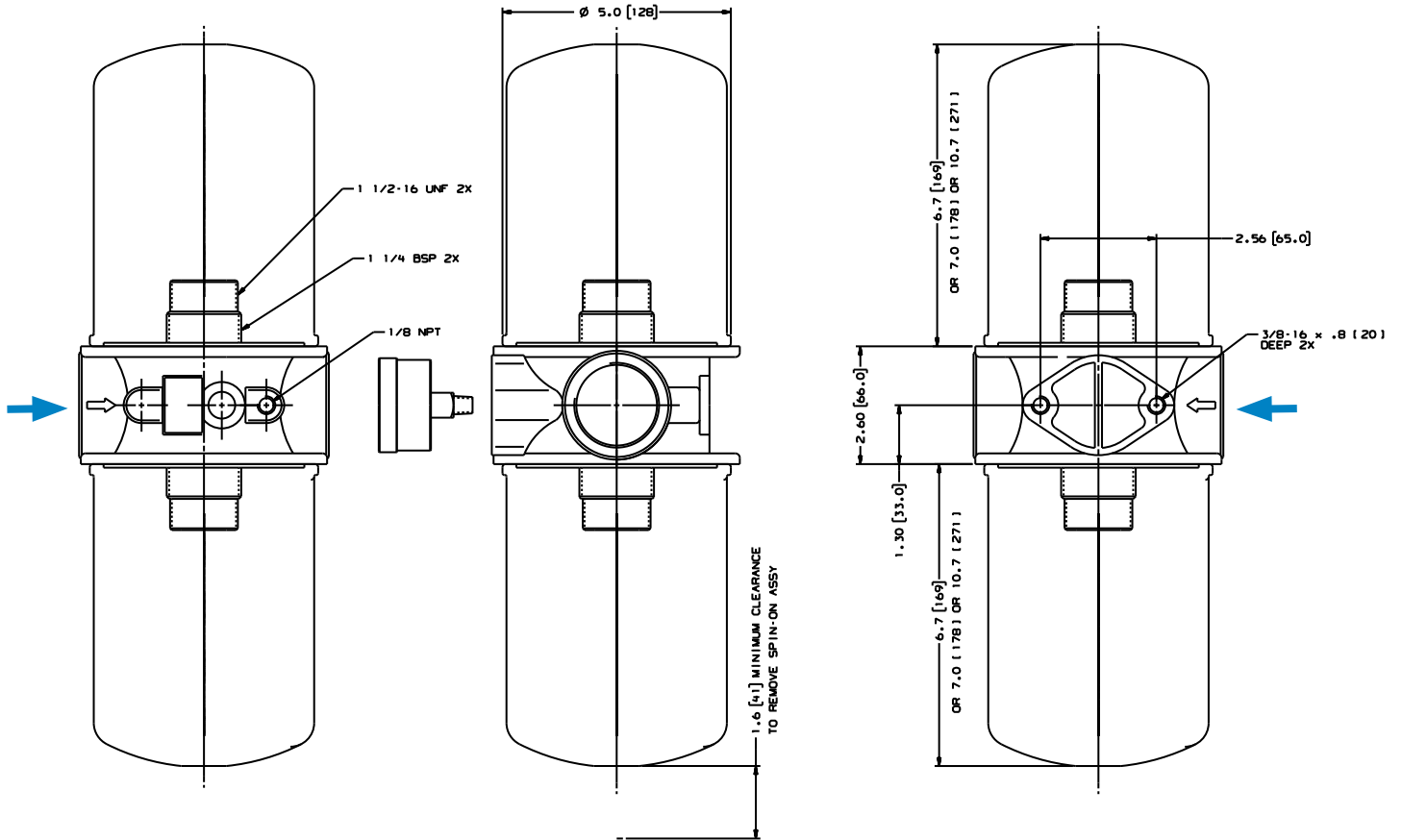



SP100/120

Max Flow: 100 gpm (379 lpm)



SP100/120 Components

Filter Choices

Media Type	$\beta_{x(c)} = 2$ Rating based on ISO 16889	$\beta_{x(e)} = 1000$	Length in	mm	Donaldson Part No.	Comments
Synteq Synthetic	<4 μm		10.7	271	P167796	Viton® O-ring & square seal kit
	6 μm		6.7	170	P167162	3-seal kit
	6 μm		10.7	271	P165762	3-seal kit
	11 μm		6.7	170	P165875	3-seal kit
	11 μm		10.7	271	P165876	3-seal kit
	13 μm		6.7	170	P167944	Viton O-ring & square seal kit
	13 μm		10.7	271	P167945	Viton O-ring & square seal kit
	23 μm		6.7	170	P165877	3-seal kit
	23 μm		10.7	271	P165878	3-seal kit
		50 μm		6.7	170	P165879
	50 μm		10.7	271	P165880	3-seal kit
Cellulose	5 μm		6.7	170	P550386	3-seal kit
	5 μm		10.7	271	P550250	3-seal kit
	7 μm		6.7	170	P550388	3-seal kit
	7 μm		10.7	271	P550251	3-seal kit
	7 μm		7.00	178	P565245	Square seal kit, 1/4" BSP thread
	17 μm		6.7	170	P550387	3-seal kit
	17 μm		10.7	271	P550252	3-seal kit
		27 μm		7.00	178	P171616
Water Absorbing	10 μm		10.7	271	P561183	Cellulose media, 3-seal kit. Absorbs 350 ml water.
Wire Mesh	150 μm		6.7	170	P550275	Stainless steel wire mesh, 3-seal kit
	150 μm		10.7	271	P550276	Stainless steel wire mesh, 3-seal kit

All models have 1½-16 UNF threads except where otherwise noted. All models measure 5.0"/127 mm outer diameter. Viton® is a registered trademark of E. I. DuPont de Nemours and Company.

Head Choice

Port Size	Bypass Rating	Gauge Ports (drill, tap, plug)	Gauge Port Location	Donaldson Part No.
1½" NPT	25 psi / 172.5 kPa / 1.72 bar	(2) 1/8" NPT	upstream & downstream sides	P563277

Note:

On a return line system the gauge port should be on the upstream side. We suggest a 25 psi bypass. If head is used on a suction line, the gauge port should be on the downstream side very low bypass.

Gaskets

Each filter ships with a 3-seal kit, containing an "L" shaped, a square cut, and an O-ring gasket seal, unless otherwise noted. Use only one of the following seals. Installation instructions can be found in the technical reference section.

 L Shaped
Use with filter heads with no groove or a wide groove.

 Square Cut
Use with filter heads with a narrow groove.

 O-Ring -246
Use with Donaldson HBK05 heads only.

Optional Filter Service Indicators

This handy pressure gauge, mounted on the side of an SP100/120 filter head, will tell you when it's time to service the filter.

Donaldson Part No.	Pressure Range	Use With Bypass Valve Rating	Type
P563978	5 to 30 psi field adj.*	15 psi / 103.4 kPa / 1.34 bar or 25 psi / 172.5 kPa / 1.72 bar or No Bypass	Return indicator, electrical
P563979	-5 to 15 in Hg field adj.*	5 psi / 34.5 kPa / .34 bar or No Bypass	Suction indicator, electrical
P563296	0 to 100 psi	15 psi / 103.4 kPa / 1.34 bar or 25 psi / 172.5 kPa / 1.72 bar or No Bypass	Return indicator, numeric scale
P563297	0 to 100 psi	15 psi / 103.4 kPa / 1.34 bar Bypass	Return indicator, color coded
P563298	0 to 100 psi	25 psi / 172.5 kPa / 1.72 bar or No Bypass	Return indicator, color-coded
P563299	0 to -30 Hg	5 psi / 34.5 kPa / .34 bar or No Bypass	Suction indicator, numeric scale



Notes
* NOT PRESET:
Setting adjustable for desired application

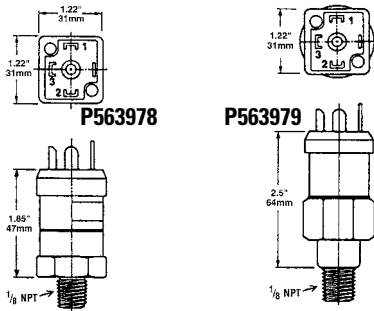

#1 Common; #2 Normally Closed;
#3 Normally Open

Instructions

1. Remove DIN adaptor
2. Remove small brass screw
3. Using 1/8" allen wrench adjust clockwise to increase set point/counter-clockwise to decrease set point
4. NO / NC

Adjustment screw located in center of electric prongs

P563296 - P563299

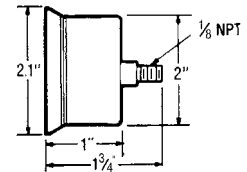

Performance Data

SP100 Filter Only
(Synthetic, 6.7\"/>

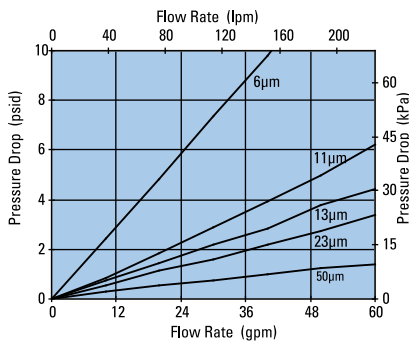

SP100 Filter Only
(Cellulose, 6.7\"/>

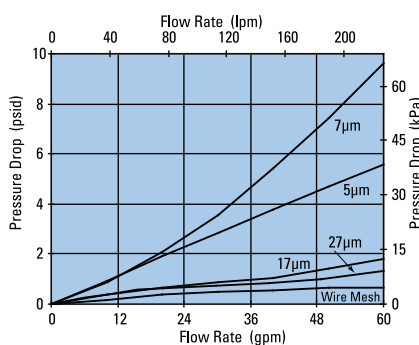

SP100/120 Head Only

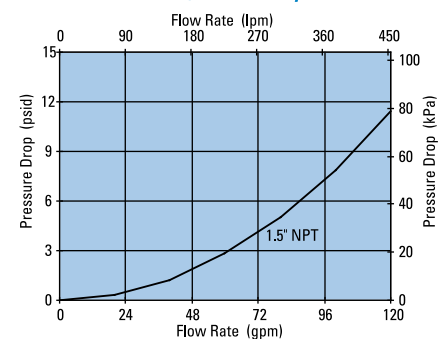

SP120 Filter Only
(Synthetic, 10.7\"/>

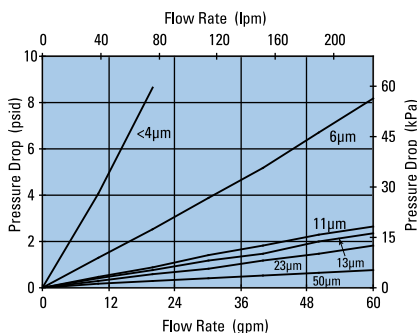

SP120 Filter Only
(Cellulose, 10.7\"/>

